

Wire Mesh Safety Grips

Pulling, Strain Relief and Support Grips for the Most Demanding Wire Management Applications

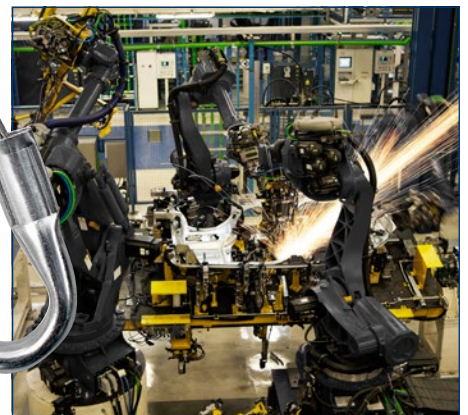



Wire Mesh Safety Grips

Table of Contents 

Grips Selection Guide3

Pulling Grips9

Strain-Relief Grips17

Support Grips22



Wire Mesh Safety Grips Selection Guide

A Large Selection of Wire Mesh Pulling, Strain-Relief and Support Grips

Leviton wire mesh safety grips are built tough to provide the strength, reliability and gripping force required for today's demanding wire management applications. They are designed to distribute stress over a large area so they can securely hold, pull or support the wire, rope, tubing or fiber optic cable to which they are applied.

Leviton wire mesh safety grips are flexible holding devices used to pull cable, rope, or tubing into place; to support it after it has been installed, to prevent cable pullout; or to provide strain-relief that reduces the arc of bend at points of wire connections or terminations. Available in a wide selection of style, weave, attachment and wire options designed to meet the highest standards for strength, flexibility, durability and longevity.

Features and Benefits

Pulling Grips

- Pulling grips are reusable tools for pulling insulated conductors and bare wires; cable, nylon and wire rope; fiber optic cable; etc. Both flexible eye and rotating eye attachments are available.

Strain-Relief Grips

- Strain-relief grips are used to connect cable or flexible conduit to electrical enclosures and equipment. This prevents pullout and bending due to tension at the inner conductors at the point of termination.

Support Grips

- Support grips distribute the weight of the vertical or sloping runs of electrical and fiber optic cable, metal rods, tubing or hose over the entire length of the grip so that the cable is not subject to damage. A variety of hangers and bales are available. These grips are also available in stainless steel for additional corrosion resistance.

Hazardous Locations

The following product categories are suitable for use in hazardous locations per Class I, Div. 2; Class II, Div. 1 & 2; and Class III, Div. 1 & 2 requirements.

Product Category	Type
Deluxe Cord Grips	Aluminum fitting

Flammability

Non-metallic Deluxe Cord Grips will not support combustion. The ratings are listed below.

Component	Rating
Wire Mesh Grip	94HB*
Fitting	94V**

*A test method used by UL to determine rate of burning and/or extent and time of burning of self-supporting plastics in horizontal position (ASTM D 635-88, IEC 707-1981, ISO/DIS 1210.2).

**A test method used by UL for measuring the comparative extinguishing characteristics of solid plastics in a vertical position (IEC 707-1981, ISO/DIS 1210.2)

GRIP SELECTION

Wet Locations

The strain-relief grips listed below are suitable for use in wet locations so long as a listed sealing ring is used between the box and the fitting (sealing ring not included).

Product Category	Type
Deluxe Cord Grips, Nylon Cord Sealing Grips and Liquid-Tight Grips	Zinc-plated steel or malleable iron fitting Nylon fitting

Types of Wire Mesh Safety Grips

Product	Description	Material	
Pulling Grips	Junior Duty	Galvanized steel wire	
	Light Duty	Galvanized steel wire	
	Medium Duty	Galvanized steel wire	
	Heavy Duty	Galvanized steel wire	
	Heavy Duty Swivel	Galvanized steel wire	
	Multi-Weave, Rotating Eye	Galvanized steel wire	
	Multi-Weave, Flexible Eye	Galvanized steel wire	
	High Strength	Galvanized steel wire	
	Slack, Offset Eye - Closed Mesh	Galvanized steel wire	
	Slack, Offset Eye - Split Lace	Galvanized steel wire	
	Slack, Offset Eye - Split Rod	Galvanized steel wire	
	Strain-Relief Grips	Wide Range (with Gasket)	Galvanized steel wire
		Nylon Cord Sealing Grips with Mesh	Nylon
Deluxe Cord Grips	Deluxe Cord Grips	Stainless steel wire	
	Liquid-Tight (metallic cond.)	Stainless steel wire	
	Liquid-tight (Non-Metallic Cond.)	Stainless steel wire	
	Connection Wire	Galvanized steel	
	Support Grips	Support Closed	Tinned bronze or stainless steel*
Support Grips	Support Closed, Heavy Duty, Long	Tinned bronze or stainless steel*	
	Support Split with Lace	Tinned bronze or stainless steel*	
	Support Split Lace, Heavy Duty, Long	Tinned bronze or stainless steel*	
	Support Split with Rod	Tinned bronze or stainless steel*	
	Bus Drop Grips	Galvanized steel wire	
Safety Springs	Spring steel		

*Stainless steel available on request. Contact your Leviton representative

Testing and Code Compliance

UL Listed	CSA Certified	NEC	JIC H 13.11
Control #965U, File #E-173944, and Control #16G5, File # E-176347	File #LR-702185	300-19 — Supporting cables in vertical raceways 351-2 — Liquid-tight flexible metal conduit installations 400-7 — Flexible cord installations 400-10 — Strain-relief at joints and terminals	Prevention of flexible hose failure

GRIP SELECTION

Selecting Proper Sized Pulling and Support Grips

Grip size is based on the outside diameter or circumference of the cable(s). Use Selection Table 1 to determine the Grip Diameter Range for one or more cables of equal diameter. Use Selection Table 2 to determine the Grip Diameter Range for cables of different diameters bundled together. (Note: In this case, the bundle must be measured.) For your convenience, the Reference Tables provide approximate values for flexible cord and AWG or MCM wire.

EQUAL DIAMETER CABLES

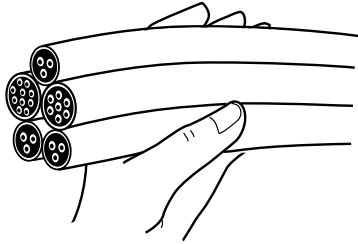

How to Select Proper Grip Size

- 1) Read across top line for number of cables in one grip
- 2) Read down for diameter of each cable
- 3) Read across line to Grip Diameter Range column.

Example: For five cables bundled together, each with a diameter of 0.42"

- 1) Locate "5 Cables" column
- 2) Read down column to range (0.38"-0.48")
- 3) Read across line to Grip Diameter Range (1.00-1.25)

Table 1: Decimal and Fractional Inch Cable Diameters — for One or More Cables of Equal Diameter

1 Cable	2 Cables	3 Cables	4 Cables	Grip Diameter Range				
0.25-0.37	$1/4$ - $3/8$	0.16-0.25	$1/64$ - $1/4$	0.15-0.22	$5/32$ - $7/32$	0.12-0.20	$1/8$ - $13/64$.250-.375
0.37-0.50	$3/8$ - $1/2$	0.25-0.36	$1/4$ - $23/64$	0.22-0.33	$7/32$ - $21/64$	0.20-0.28	$13/64$ - $9/32$.375-0.50
0.50-0.62	$1/2$ - $5/8$	0.27-0.36	$17/64$ - $23/64$	0.26-0.33	$17/64$ - $21/64$	0.24-0.28	$15/64$ - $9/32$	0.50-0.75
0.62-0.75	$5/8$ - $3/4$	0.36-0.45	$23/64$ - $29/64$	0.33-0.36	$21/64$ - $23/64$	0.28-0.31	$9/32$ - $5/16$	0.62-0.75
0.75-1.00	$3/4$ -1	0.45-0.60	$29/64$ - $39/64$	0.36-0.49	$23/64$ - $31/64$	0.31-0.42	$5/16$ - $27/64$	0.75-1.00
1.00-1.25	1 - $1 1/4$	0.60-0.76	$39/64$ - $49/64$	0.49-0.63	$33/64$ - $5/8$	0.42-0.54	$27/64$ - $35/64$	1.00-1.25
1.25-1.50	$1 1/4$ - $1 1/2$	0.76-0.91	$49/64$ - $29/32$	0.63-0.76	$5/8$ - $49/64$	0.54-0.65	$35/64$ - $21/32$	1.25-1.50
1.50-1.75	$1 1/2$ - $1 3/4$	0.91-1.08	$29/32$ - $1 5/64$	0.76-0.89	$49/64$ - $57/64$	0.65-0.77	$21/32$ - $49/64$	1.50-1.75
1.75-2.00	$1 3/4$ -2	1.08-1.23	$1 5/64$ - $1 5/64$	0.89-1.02	$57/64$ - $1 1/64$	0.77-0.88	$49/64$ - $7/8$	1.75-2.00
2.00-2.50	2 - $2 1/2$	1.23-1.54	$1 5/64$ - $1 35/64$	1.02-1.28	$1 1/64$ - $1 9/32$	0.88-1.00	$7/8$ -1	2.00-2.50
2.50-3.00	$2 1/2$ -3	1.54-1.84	$1 35/64$ - $1 27/32$	1.28-1.53	$1 9/32$ - $1 17/32$	1.10-1.32	$1 3/32$ - $1 21/64$	2.50-3.00
3.00-3.50	3 - $3 1/2$	1.84-2.15	$1 27/32$ - $2 5/32$	1.53-1.79	$1 17/32$ - $1 51/64$	1.32-1.54	$1 21/64$ - $1 35/64$	3.00-3.50
3.50-4.00	$3 1/2$ -4	2.15-2.45	$2 5/32$ - $2 29/64$	1.79-2.05	$1 51/64$ - $2 3/64$	1.54-1.76	$1 35/64$ - $1 49/64$	3.50-4.00
5 Cables	6 & 7 Cables	8 Cables	9 Cables	Grip Diameter Range				
0.11-0.14	$7/64$ - $9/64$	0.10-0.11	$3/32$ - $7/64$	0.09-0.10	$3/32$ - $7/64$	0.06-0.09	$1/16$ - $3/32$.250-.375
0.14-0.25	$9/64$ - $1/4$	0.11-0.25	$7/64$ - $1/4$	0.10-0.20	$7/64$ - $13/64$	0.09-0.19	$3/32$ - $3/16$.375-0.50
0.21-0.25	$7/32$ - $1/4$	0.19-0.22	$3/16$ - $7/32$	0.17-0.20	$11/64$ - $13/64$	0.15-0.19	$5/32$ - $3/16$	0.50-0.75
0.25-0.29	$1/4$ - $19/64$	0.22-0.26	$7/32$ - $17/64$	0.20-0.23	$13/64$ - $15/64$	0.19-0.22	$3/16$ - $7/32$	0.62-0.75
0.29-0.38	$19/64$ - $3/8$	0.26-0.34	$17/64$ - $11/32$	0.23-0.31	$15/64$ - $5/16$	0.22-0.31	$7/32$ - $5/16$	0.75-1.00
0.38-0.48	$3/8$ - $31/64$	0.34-0.43	$11/32$ - $7/16$	0.31-0.39	$5/16$ - $25/64$	0.29-0.36	$19/64$ - $23/64$	1.00-1.25
0.48-0.58	$31/64$ - $37/64$	0.43-0.52	$7/16$ - $33/64$	0.39-0.46	$25/64$ - $15/32$	0.36-0.43	$23/64$ - $7/16$	1.25-1.50
0.58-0.67	$37/64$ - $43/64$	0.52-0.60	$33/64$ - $39/64$	0.46-0.54	$15/32$ - $35/64$	0.43-0.49	$7/16$ - $31/64$	1.50-1.75
0.67-0.77	$43/64$ - $49/64$	0.60-0.69	$39/64$ - $11/16$	0.54-0.62	$35/64$ - $5/8$	0.49-0.57	$31/64$ - $37/64$	1.75-2.00
0.77-0.96	$49/64$ - $31/32$	0.69-0.86	$11/16$ - $55/64$	0.62-0.77	$5/8$ - $49/64$	0.57-0.72	$37/64$ - $23/32$	2.00-2.50
0.96-1.16	$31/32$ - $1 5/32$	0.86-1.03	$55/64$ - $1 1/32$	0.77-0.93	$49/64$ - $15/16$	0.72-0.86	$23/32$ - $55/64$	2.50-3.00
1.16-1.35	$1 5/32$ - $1 23/64$	1.03-1.20	$1 1/32$ - $1 13/64$	0.93-1.08	$15/16$ - $1 5/64$	0.86-1.00	$55/64$ -1	3.00-3.50
1.35-1.54	$1 23/64$ - $1 35/64$	1.20-1.37	$1 13/64$ - $1 3/8$	1.08-1.24	$1 5/64$ - $1 15/64$	1.00-1.14	1 - $19/64$	3.50-4.00

GRIP SELECTION

DIFFERENT DIAMETER CABLES

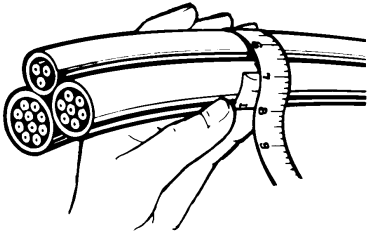

How to Measure Grip Circumference Range

- 1) Determine grip circumference range by measuring circumference of the entire bundle of cables to be held (as shown in illustration)

How to Select Proper Grip Size

Example: For three different diameter cables bundled together with a measured circumference of 6.35"

- 1) Read down "Inches (Decimal)" column for 6.35" (6.29-7.86 in.)
- 2) Read across line to Grip Diameter Range (2.00-2.50)
- 3) Read across line to Grip Diameter Range Column

Table 2: Grip Circumference Range — for Cables of Different Diameter

Inches (Fractional)	Inches (Decimal)	Grip Diameter Range
$2 \frac{5}{32} - 1 \frac{11}{64}$	0.78-1.17	.250-.375
$1 \frac{11}{64} - 1 \frac{37}{64}$	1.17-1.57	.375-0.50
$1 \frac{37}{64} - 1 \frac{15}{16}$	1.57-1.94	0.50-.625
$1 \frac{15}{16} - 2 \frac{3}{8}$	1.94-2.37	0.62-0.75
$2 \frac{3}{8} - 3 \frac{5}{32}$	2.37-3.15	0.75-1.00
$3 \frac{5}{32} - 3 \frac{15}{16}$	3.15-3.94	1.00-1.25
$3 \frac{15}{16} - 4 \frac{23}{32}$	3.94-4.72	1.25-1.50
$4 \frac{23}{32} - 5 \frac{33}{64}$	4.72-5.51	1.50-1.75
$5 \frac{33}{64} - 6 \frac{19}{64}$	5.51-6.29	1.75-2.00
$6 \frac{19}{64} - 7 \frac{55}{64}$	6.29-7.86	2.00-2.50
$7 \frac{55}{64} - 9 \frac{7}{16}$	7.86-9.43	2.50-3.00
$9 \frac{7}{16} - 11 \frac{11}{64}$	9.43-11.01	3.00-3.50
$11 \frac{11}{64} - 12 \frac{37}{64}$	11.01-12.58	3.50-4.00

Reference Table — Cord Diameters

For your convenience, the following are nominal overall diameters (in inches) for flexible cord.

Wire Size and Type	Conductors 2	Conductors 3	Conductors 4	Conductors 5
18 SO, STO	.36	.38	.41	.49
18 SJO, SJTO	.30	.32	.35	—
16 SO, STO	.39	.41	.44	.52
16 SJO, SJTO	.32	.34	.37	—
14 SO, STO	.52	.55	.59	.67
12 SO, STO	.60	.62	.68	.74
10 SO, STO	.65	.69	.74	.8
8 SO, STO	.83	.88	.99	1.08
6 SO, STO	.99	1.04	1.12	1.25

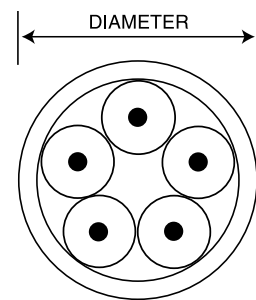

GRIP SELECTION

Selecting Proper Sized Pulling and Support Grips

Reference Table AWG or MCM Diameters

This table is to be used as a guide only. Sizes may vary by manufacturer.

AWG or MCM	Approx. Dia. (inches) THHN	Approx. Dia. (inches) THW
14	.105	.162
12	.122	.179
10	.153	.199
8	.201	.259
6	.257	.323
4	.328	.372
3	.356	.401
2	.388	.433
1	.450	.508
1/0	.491	.549
2/0	.537	.595
3/0	.588	.647
4/0	.646	.705
250	.716	.788
300	.771	.843
350	.822	.895
400	.869	.942
500	.955	1.03
600	1.06	1.14
700	1.13	1.21
750	1.16	1.25
1000	1.32	1.40

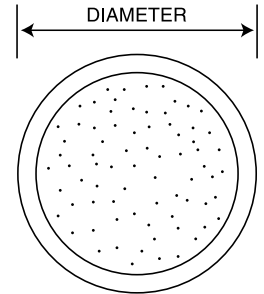

GRIP SELECTION

Strength Information

The approximate breaking strength of any Leviton wire mesh safety grip is based on working load information established by our engineering laboratories. In making these determinations, it is not possible to cover all applications and operating conditions. Variables such as diameter, gripping surface, number of items gripped, tension, movement, attachments, abrasion, corrosion, prior use and abuse must be assessed by the user. Greater safety factors should be utilized when the conditions of application are vague or unknown.

For specific applications where strength and holding power are important, consult Leviton's Technical Services Department. To determine the recommended working load safety factor for listed cable grips, divide the approximate breaking strength by 5 for pulling grips and by 10 for support grips. Leviton maintains a 6 Sigma Safety Factor for this recommended working load (using average break strengths obtained on new grips under lab test conditions).

Example: For pulling grips — $33,000 \div 5 = 6,600$ lbs., which is the workload factor.

Example: For support grips — $10,080 \div 10 = 1,008$ lbs., which is the workload factor.

All warranties on product quality and performance are based on wire mesh safety grips that are properly stored and handled by the user, and grips that are maintained and inspected at a proper frequency in keeping with their use and condition.

Grip Cable Range — Fraction-Decimal-Millimeter Conversion		
Inches (Fractional)	Inches (Decimal)	Metric (mm)
$1/4$ - $23/64$	0.25-0.36	6.35-9.13
$3/8$ - $31/64$	0.37-0.49	9.52-12.30
$1/2$ - $39/64$	0.50-0.61	12.70-15.48
$5/8$ - $47/64$	0.62-0.74	15.88-18.65
$3/4$ - $63/64$	0.75-0.99	19.05-25.00
1- $1^{15/64}$	1.00-1.24	25.40-31.35
$1^{1/4}$ - $1^{31/64}$	1.25-1.49	31.75-37.70
$1^{1/2}$ - $1^{63/64}$	1.50-1.99	38.10-50.40
2- $2^{31/64}$	2.00-2.49	50.80-63.10
$2^{1/2}$ - $2^{63/64}$	2.50-2.99	63.50-75.80
3- $3^{31/64}$	3.00-3.49	76.20-88.50
$3^{1/2}$ - $3^{63/64}$	3.50-3.99	88.90-101.20

Pulling Grips

Leviton pulling grips are reusable tools for pulling bare conductors, insulated wires, synthetic rope, wire rope, and fiber optic cable. These grips do not damage the cable, as the tension remains uniform throughout the length of the grip. The mesh responds to fit either a single cable or a bundle of cables. Leviton pulling grips may be used for pulling cable on overhead or underground applications, for stringing service or communication lines into factories, for pulling wire through conduit, and for underground electrical pulls. Leviton pulling grips are woven in galvanized steel for greater strength and longer life. Leviton also offers pulling kits that come in a vinyl mat with pockets that can be rolled and tied.



Bale Eye

Attachment flexes to follow line of pull with plastic tubing on bale.



Flexible Rope Eye

Bale has no plastic tubing for better flexibility.



Offset Flexible Eye

For easy attachment of the pulling line.



Rotating Eye

For use in changing wire rope in large cranes and derricks.

Single Weave Grips

Flexible Eye, Junior Duty

Cat. No.	Cable Dia. Range (inches)	Approximate (lbs.) Break Strength*	Mesh Length (inches)
L8500	0.25-0.36	1,700	4.25
L8501	0.37-0.49	1,700	7.0
L8502	0.50-0.61	1,700	8.5
L8503	0.62-0.74	2,800	10.0
L8504	0.75-0.99	4,100	10.0
L8505	1.00-1.24	4,100	11.5

*To determine workload safety factor, divide approximate break strength by 5



L8503

Junior Duty Series Grips are indispensable tools for electricians with small job requirements. They are used to connect insulated wire bundles to pulling tape or to pull wire rope through conduit.

Flexible Eye, Junior Duty — Kit

Kit Cat. No.	Description
L8510	Kit includes one of each Cat. No. L8500, L8501, L8502, L8503, L8504, L8505

*To determine workload safety factor, divide approximate break strength by 5



L8510

Flexible Rope Eye, Light Duty, Short

Cat. No.	Cable Dia. Range (inches)	Approximate (lbs.) Break Strength*	Mesh Length (inches)
L8511	0.50-0.61	3,400	12.75
L8512	0.62-0.74	4,100	14.0
L8513	0.75-0.99	4,100	14.75
L8514	1.00-1.24	5,800	16.5
L8515	1.25-1.49	5,800	17.0
L8516	1.50-1.74	7,500	20.0
L8517	1.75-1.99	10,000	23.5
L8518	2.00-2.49	10,000	23.0
L8519	2.50-2.99	13,000	23.75

*To determine workload safety factor, divide approximate break strength by 5

L8511
Light Duty Grips are the most economical pulling grips for many applications, such as industrial plant wiring, rewiring, and underground electrical pulls.

PULLING GRIPS | Single Weave | Multi-Weave Fiber Optic

Flexible Rope Eye, Light Duty, Medium			
Cat. No.	Cable Dia. Range (inches)	Approximate (lbs.) Break Strength*	Mesh Length (inches)
L8523	0.50-0.61	3,400	20.0
L8524	0.62-0.74	4,100	19.0
L8525	0.75-0.99	4,100	25.5
L8526	1.00-1.24	7,500	26.0
L8527	1.25-1.49	7,500	27.75
L8528	1.50-1.99	7,500	32.0
L8529	2.00-2.49	10,000	32.75
L8530	2.50-2.99	13,000	38.0
L8531	3.00-3.49	16,200	39.0
L8532	3.50-3.99	19,400	38.0

*To determine workload safety factor, divide approximate break strength by 5

Flexible Rope Eye, Light Duty, Medium — Kit	
Kit Cat. No.	Description
L8540	Kit includes one of each Cat. No., L8525, L8526, L8528, L8529

*To determine workload safety factor, divide approximate break strength by 5

Multi-Weave Fiber Optic Grips

Fiber optic pulling grips are used for installation of fiber optic communication lines. They easily install on cables and are reusable. Applications include underground, overhead, through-conduit and enclosure type pulls. Leviton fiber optic pulling grips are two-in-one reusable grips: the same tool features both a flexible eye and a swivel eye. The rounded, flexible eye attaches easily to pulling lines and allows smoother passage through tight spaces than needle-eye designs.

Flexible/Swivel Eye 					
Cat. No.	Cable Dia. Range (inches)	Approx. (lbs.) Break Strength*	Length (inches)		
			Bale (Dim. A)	Mesh (Dim. M)	Nose Dia.
L8801	.10-.20	1,000	4.75	9	0.8
L8802	.21-.35	1,500	4.75	14	0.8
L8803	.32-.48	2,200	5.00	18	0.9
L8804	.42-.61	2,800	5.00	21	0.9
L8805	.53-.74	3,300	5.00	24	1.2
L8806	.64-.87	4,700	5.00	27	1.2

*To determine workload safety factor, divide approximate break strength by 5

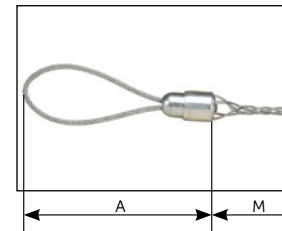

L8801

Fiber Optic Grips are made to pull delicate communication and data lines that have a much smaller cable diameter.

PULLING GRIPS | Single/Double Weave Bale Eye Grips

Single/Double Weave Bale Eye Grips

This series is recommended for heavy or rugged applications and is ideally suited for overhead and underground installations. They are offered in short, standard or long mesh lengths.

Medium Duty, Short						
Cat. No.	Cable Dia. Range (inches)	Nominal Grip Size (inches)	Approx. (lbs.) Break Strength*	Length (inches) Bale (Dim. A)	Mesh (Dim. M)	Eye Size (inches)
L8551	0.50-0.61	0.55	4,500	8	24.5	7/32
L8552	0.62-0.74	0.68	5,600	8	24.5	1/4
L8553	0.75-0.99	0.87	6,800	8	24.5	1/4
L8554	1.00-1.49	1.25	9,600	9	24.5	5/16
L8555	1.50-1.99	1.75	16,400	11	24.5	7/16
L8556	2.00-2.49	2.25	18,500	12	24.75	7/16
L8557	2.50-2.99	2.75	24,500	12	27.0	1/2
L8558	3.00-3.49	3.25	24,500	14	27.5	1/2
L8559	3.50-3.99	3.75	31,000	14	27.75	5/8

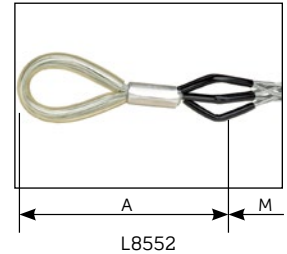

Medium Duty			
Cat. No.	Cable Dia. Range (inches)	Approx. (lbs.) Break Strength*	Mesh Length (inches)
L8541	0.37-0.49	2,500	13.5
L8542	0.50-0.74	3,400	16.0
L8543	0.75-0.99	5,500	20.0
L8544	1.00-1.24	8,100	26.0
L8545	1.25-1.49	8,100	30.0
L8546	1.50-1.74	8,100	36.0



L8545
Single/Double Weave Pulling Grips are ideal for longer pull applications.

Medium Duty — Kit	
Kit Cat. No.	Description
L8550	Kit includes one of each Cat. No. L8541, L8542, L8543, L8544, L8545, L8546

Medium Duty, Standard Length						
Cat. No.	Cable Dia. Range (inches)	Nominal Grip Size (inches)	Approx. (lbs.) Break Strength*	Length (inches) Bale (Dim. A)	Mesh (Dim. M)	Eye Size (inches)
L8563	0.75-0.99	0.87	6,800	9	40.5	1/4
L8564	1.00-1.49	1.25	9,600	9	40.5	5/16
L8566	2.00-2.49	2.25	18,500	12	43.5	7/16
L8567	2.50-2.99	2.75	24,500	12	43.5	1/2
L8568	3.00-3.49	3.25	24,500	14	43.5	1/2
L8569	3.50-3.99	3.75	31,000	14	56.0	5/8

Medium Duty, Standard Length — Kit	
Kit Cat. No.	Description
L8560	Kit includes one of each Cat. No. L8563, L8564, L8566

Heavy Duty, Long				
Cat. No.	Cable Dia. Range (inches)	Nominal Grip Size (inches)	Approx. (lbs.) Break Strength*	Mesh (inches) (Dim. M)
L8573	1.00-1.49	1.25	11,600	48
L8575	2.00-2.49	2.25	19,400	48
L8576	2.50-2.99	2.75	25,900	48
L8577	3.00-3.49	3.25	25,900	48

Note: See installation instructions supplied with grip for recommended swivels, links and clamps or accessories listing.

*To determine workload safety factor, divide approximate break strength by 5

PULLING GRIPS | Double Weave Rotating Eye Grips

Double Weave — Rotating Eye Grips

These grips feature a double weave of galvanized steel strands for greater strength and added mesh contact with the cable. Leviton double weave pulling grips are designed to handle longer or heavier pulling jobs such as installation of underground cables, communication lines, and service lines. Double weave pulling grips have a forged steel compact rotating eye which can be attached to a swivel.

Heavy Duty, Short 						
Cat. No.	Cable Dia. Range (inches)	Nominal Grip Size	Approx. (lbs.) Break Strength*	Length (inches) Bale (Dim. A)	Mesh (Dim. M)	Eye Size (inches)
L8581	0.50-0.61	0.55	5,600	5	11	7/8
L8582	0.62-0.74	0.68	6,800	5	11	7/8
L8583	0.75-0.99	0.87	9,600	6	20	1
L8584	1.00-1.24	1.12	12,800	7	20	1 3/8
L8585	1.25-1.49	1.37	12,800	7	21	1 3/8
L8586	1.50-1.99	1.74	16,400	7	25	1 3/8
L8587	2.00-2.49	2.24	27,200	8	26	1 5/8
L8588	2.50-2.99	2.74	33,000	10	28	1 7/8
L8589	3.00-3.49	3.24	41,000	10	30	1 7/8
L8592	4.00-4.49	4.24	48,000	10	33	1 7/8

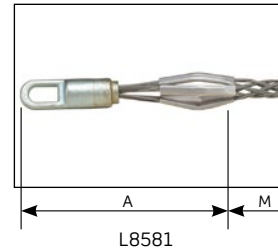

Note: See installation instructions supplied with grip for recommended swivels, links and clamps or accessories listing.
 *To determine workload safety factor, divide approximate break strength by 5

Heavy Duty, Standard Length 						
Cat. No.	Cable Dia. Range (inches)	Nominal Grip Size	Approx. (lbs.) Break Strength*	Length (inches) Bale (Dim. A)	Mesh (Dim. M)	Eye Size (inches)
L8601	0.50-0.61	0.55	5,600	5	16	7/8
L8602	0.62-0.74	0.68	6,800	5	16	7/8
L8603	0.75-0.99	0.87	9,600	6	32	1
L8604	1.00-1.24	1.12	16,400	7	33	1 3/8
L8605	1.25-1.49	1.74	16,400	7	34	1 3/8
L8606	2.00-2.49	2.24	27,200	9	36	1 5/8
L8607	2.50-2.99	2.74	33,000	10	38	1 7/8
L8608	3.00-3.49	3.24	41,000	10	39	1 7/8
L8609	3.50-3.99	3.74	48,000	10	41	1 7/8
L8611	4.00-4.49	4.24	48,000	10	42	1 7/8
L8612	4.50-4.99	4.74	48,000	10	58	1 7/8
L8613	5.00-5.99	5.49	48,000	10	60	1 7/8
L8614	6.00-6.99	6.49	48,000	10	66	1 7/8

Note: See installation instructions supplied with grip for recommended swivels, links and clamps or accessories listing.
 *To determine workload safety factor, divide approximate break strength by 5

Heavy Duty, Standard Length—Kit 	
Kit Cat. No.	Description
L8600	Kit includes one of each Cat. No., L8603, L8604, L8605, L8606

PULLING GRIPS | Multi- Weave Grips

Multi-Weave Grips

Leviton multi-weave pulling grips are constructed of high strength galvanized steel strands and are designed for pulling aluminum or copper bare conductor, wire rope and insulated cables. These grips are used in applications such as distribution line stringing and overhead transmission. Multi-weave pulling Grips are available with a flexible or rotating eye which can be attached to a swivel. The forged steel flexible eye will thread through sheaves and blocks without binding, but is not a swivel and will not turn under tension. The rotating eye can turn to relieve pulling torque when tension is relaxed.

Rotating Eye							
Cat. No.	Cable Dia. Range (inches)	Nominal Grip Size	Approx. (lbs.) Break Strength*	Length (inches) Bale (Dim. A)	Mesh (Dim. M)	Color Code	Eye Size (inches)
L8621	0.25-0.49	3/8	6,800	5	26	Dk. Green	7/8
L8622	0.50-0.74	5/8	10,000	6	32	Brown	1
L8623	0.75-0.99	7/8	14,400	6	41	Lt. Blue	1
L8624	1.00-1.24	1 1/8	24,600	8	52	Gold	1 3/8
L8625	1.25-1.49	1 3/8	30,600	8	56	Black	1 5/8
L8626	1.50-1.74	1 5/8	30,600	9	60	Red	1 7/8
L8627	1.75-2.24	2	48,000	10	70	Dk. Blue	1 7/8
L8628	2.00-2.49	2 1/4	48,000	10	50	Yellow	1 7/8
L8632	3.50-3.99	3 3/4	48,000	10	56	Lt. Green	1 7/8

*To determine workload safety factor, divide approximate break strength by 5

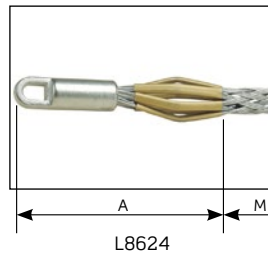

Flexible Eye							
Cat. No.	Cable Dia. Range (inches)	Nominal Grip Size	Approx. (lbs.) Break Strength*	Length (inches) Bale (Dim. A)	Mesh (Dim. M)	Color Code	Eye Size (inches)
L8641	0.25-0.49	3/8	6,800	9	26	Dk. Green	1/4
L8642	0.50-0.74	5/8	10,000	9	32	Brown	5/16
L8643	0.75-0.99	7/8	14,400	11	41	Lt. Blue	3/8
L8644	1.00-1.24	1 1/8	24,600	12	52	Gold	1/2
L8645	1.25-1.49	1 3/8	30,600	12	56	Black	1/2
L8646	1.50-1.74	1 5/8	30,600	12	60	Red	1/2
L8647	1.75-2.24	2	48,000	15	70	Dk. Blue	5/8

Note: It is recommended that a swivel be used for release of torque during a pull. Use a connecting link when a swivel is not needed. Do not run grips or swivels over bullwheels while under tension. Do not use Multi-Weave for pulling rope. When higher loads are required, use Leviton's high strength-style pulling grips. See installation instructions supplied with grip for recommended swivels, links and clamps or accessories listing. *To determine workload safety factor, divide approximate break strength by 5

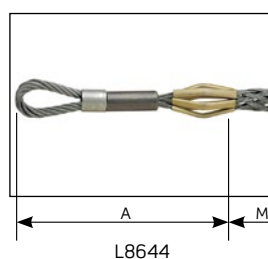

PULLING GRIPS | High Strength Grips

High Strength Grips

High strength pulling grips are designed for situations where load and safety considerations require an extra high strength grip. They are most commonly used for attaching pulling lines to conductors, conductors to running boards, and conductor-to-conductor connections. These grips can be used for pulling bare or insulated conductor, wire rope or synthetic rope. A feed tube is used when assembling synthetic rope¹ into the high strength pulling grip and is required on the two largest grip sizes.

Multi-Weave Flexible Eye 							
Cat. No.	Grip Range O.D. (inches) Rope*	Conductor (inches)	Approx. (lbs.) Break Strength**	Length (inches) Bale (Dim. A)	Mesh (Dim. M)	Color Code	Flexible Eye Size (inches)
L8660	0.25-0.65	0.19-0.37	6,500	10	24	Black	.218
L8661	0.50-0.90	0.38-0.62	14,000	13	26	Dk. Green	.375
L8662	0.75-1.10	0.63-0.87	20,000	14	48	Red	.437
L8663	1.00-1.50	0.88-1.12	30,600	15	60	Dk. Blue	.500
L8664	1.25-1.70	1.13-1.37	46,800	18	76	Yellow	.625
L8665	1.50-2.10	1.38-1.90	66,500	24	89	Aluminum	.750

*For rope, select smallest size grip which meets required workload.

**To determine workload safety factor, divide approximate break strength by 5

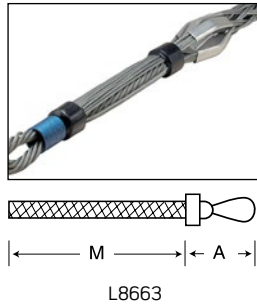

SPOTLIGHT

Recommended Rope Assembly Using High Strength Feed Tube

- 1) Insert feed tube into high strength pulling grip
- 2) Insert rope end fully into feed tube
- 3) Hold rope in feed tube by pinning rope to the ground with end of tube. Pull mesh down onto feed so feed tube nose protrudes through shoulder protectors as shown
- 4) Push mesh to end of feed tube and pull feed tube through mesh. When tube is pulled, the mesh gripping action will hold rope in place
- 5) Position rope so that its end is inside the shoulder protectors. Remove slack from mesh by smoothing mesh tight to rope
- 6) Apply clamps to mesh end

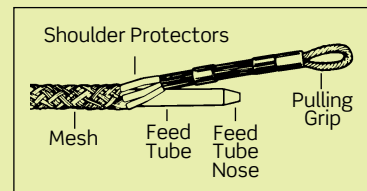

Split-Lace/Split-Rod Attachments

(For use where end of grip closest to the bale fitting, thread the lacing through the first two loops of the split, pulling the lace through until the ends are centered evenly. Cross the laces and thread them through the next two loops, and so on down the grip, being careful not to pull the lacing too tight. Spacing of the laced closure should be approximately the same as the mesh weave. When the end of grip is reached, twist the lacing strands tightly together, wrapping the ends of the lace around the grip and twisting again to secure. Excess length may be cut off. Split grips with rod closing are economical, since they are quickly installed, and are reusable. Simply wrap the grip around the cable and thread the rod through the loops using a corkscrew motion. To remove, pull the rod out and the grip is ready for re-use.)

Beginning at the end of the grip closest to the bale fitting, thread the lacing through the first two loops of the split, pulling the lace through until the ends are centered evenly. Cross the laces and thread them through the next two loops, and so on down the grip, being careful not to pull the lacing too tight. Spacing of the laced closure should be approximately the same as the mesh weave. When the end of grip is reached, twist the lacing strands tightly together, wrapping the ends of the lace around the grip and twisting again to secure. Excess length may be cut off. Split grips with rod closing are economical, since they are quickly installed, and are reusable. Simply wrap the grip around the cable and thread the rod through the loops using a corkscrew motion. To remove, pull the rod out and the grip is ready for re-use.

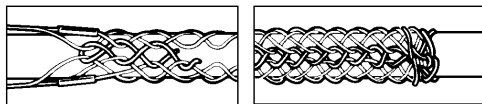

Split-Lace

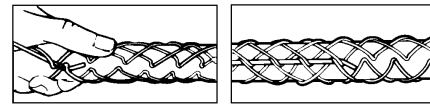

Split-Rod

Slack Grips

Slack grips are reusable grips used for pulling slack in underground cable preparatory to final placement. They may also be used for cable removal. Slack grips feature an offset eye for easy attachment to the pulling line.

Closed Mesh, Double Weave, Offset Eye, Heavy Duty, Medium

Cat. No.	Cable Dia. Range (inches)	Approx. (lbs.) Break Strength*	Mesh Length (inches)
L8671	0.75-0.99	3,000	13
L8672	1.00-1.24	4,200	16
L8673	1.25-1.49	5,500	17
L8674	1.50-1.74	7,400	18
L8675	1.75-1.99	11,000	19
L8676	2.00-2.49	11,000	20
L8677	2.50-2.99	11,000	21
L8678	3.00-3.49	16,000	22
L8679	3.50-3.99	16,000	23

*To determine workload safety factor, divide approximate break strength by 5



L8671

Closed Mesh, Double Weave, Offset Eye, Heavy Duty, Long

Cat. No.	Cable Dia. Range (inches)	Approx. (lbs.) Break Strength*	Mesh Length (inches)
L8681	0.75-0.99	3,000	21
L8684	1.50-1.74	7,400	26
L8685	2.00-2.49	11,000	27
L8686	2.50-2.99	11,000	30

*To determine workload safety factor, divide approximate break strength by 5

PULLING GRIPS | Slack Grips

Split Lace, Double Weave, Offset Eye, Heavy Duty, Medium

Cat. No.	Cable Dia. Range (inches)	Approx. (lbs.) Break Strength*	Mesh Length (inches)
L8691	0.75-0.99	3,000	13
L8692	1.00-1.24	4,100	16
L8693	1.25-1.49	4,100	17
L8694	1.50-1.74	5,500	18
L8695	1.75-1.99	7,300	19
L8696	2.00-2.49	7,300	20
L8697	2.50-2.99	7,300	21
L8699	3.50-3.99	11,000	23

*To determine workload safety factor, divide approximate break strength by 5



L8703

Split Lace, Double Weave, Offset Eye, Heavy Duty, Long

Cat. No.	Cable Dia. Range (inches)	Approx. (lbs.) Break Strength*	Mesh Length (inches)
L8703	1.25-1.49	4,100	24
L8705	2.00-2.49	7,300	27
L8706	2.50-2.99	7,300	30
L8707	3.00-3.49	9,200	33

*To determine workload safety factor, divide approximate break strength by 5

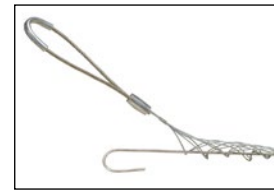

L8711

Split Rod, Single Weave, Offset Eye, Heavy Duty, Medium

Cat. No.	Cable Dia. Range (inches)	Approx. (lbs.) Break Strength*	Mesh Length (inches)
L8711	0.50-0.61	1,800	7
L8712	0.62-0.74	1,900	9
L8713	0.75-0.99	3,000	11
L8714	1.00-1.24	4,100	12
L8715	1.25-1.49	5,700	14
L8716	1.50-1.74	5,800	16
L8717	1.75-1.99	7,700	17
L8718	2.00-2.49	9,300	20
L8719	2.50-2.99	11,300	21
L8721	3.00-3.49	15,100	22
L8722	3.50-3.99	15,100	25

*To determine workload safety factor, divide approximate break strength by 5

STRAIN-RELIEF GRIPS | Wide-Range Grips | Cord Sealing Grips

Strain-Relief Grips

Strain-relief grips are used to connect cords or cable to electrical enclosures and equipment. These grips prevent pullout due to tension and limit the arc of bend at the point of entry; strain is distributed over the length of mesh rather than concentrated at one point or transferred to the internal termination.

Wide-Range Grips

Wide-range grips are recommended for use in the wiring of enclosures, power boxes, machine tools, and power centers. They have an anodized aluminum body, galvanized steel mesh and include an insulated bushing (dust-tight).

Single Weave Galvanized Steel Mesh  				
Cat. No.	Cable Dia. Range (Inches)	NPT Size (Inches)	Mesh Length @ Nominal Dia. (Inches)	Minimum Distance Between Grips (Inches)
L7501	0.22-0.32	1/2	4	1 1/4
L7502	0.30-0.43	1/2	4 1/2	1 1/4
L7503	0.40-0.54	1/2	5 1/2	1 1/4
L7504	0.52-0.73	3/4	6 1/2	1 1/2
L7505	0.70-0.97	1	8	1 7/8
L7506	0.94-1.25	1 1/4	9	2 3/8
L7507	1.20-1.50	1 1/2	11	2 5/8
L7508	1.40-1.75	2	13	3 1/4
L7509	1.62-2.00	2 1/2	13 1/2	3 5/8
L7511	2.00-2.45	2 1/2	13 1/2	3 5/8

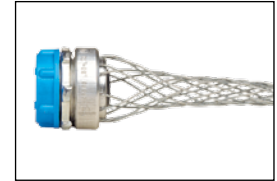



L7504
Galvanized steel mesh

Cord Sealing Grips

Cord sealing grips with mesh are nylon devices used to connect electrical cables to boxes, cabinets, pushbuttons, enclosures, etc. They are liquid-tight devices that are highly resistant to impact and corrosion. Non-metallic cord sealing grips will not support combustion. The ratings are: Wire Mesh Grip-94 HB and Fitting-94V-2.

Cord sealing grip products are suitable for use in wet locations so long as a listed sealing ring is used between the box and the fitting (sealing ring not included).

Nylon Cord Sealing Grips with Mesh, Straight and 90°   **					
Stainless Steel Mesh		Non-Metallic Mesh		Cable Dia. Range (Inches)	NPT (Form Size)
Straight	90°	Straight	90°		
L7521	—	L7522	L7524	.187-.250	1/2" (F2)
—	L7527	—	L7528	.250-.312	1/2" (F2)
—	L7532	—	L7533	.312-.375	1/2" (F2)
—	L7536	—	—	.375-.437	1/2" (F2)
L7538	L7541	L7539	L7542	.437-.500	1/2" (F2)
L7543*	L7544*	—	—	.500-.562	1/2" (F2)
L7545*	L7546*	—	—	.562-.625	1/2" (F2)
L7601	—	L7602	L7604	.187-.250	3/4" (F3)
L7605	—	—	—	.250-.375	3/4" (F3)
—	L7612	—	—	.375-.437	3/4" (F3)

*Cable jacket may have to be stripped for clearance.
Note: F2, F3 and F4 are fitting form sizes.

**Cord Sealing Grips with non-metallic mesh are UL Listed and CSA Certified.
Cord Sealing Grips with stainless steel mesh are CSA Certified only

Continued on next page



L7521
Straight—SS mesh



L7527
90°—SS mesh

STRAIN-RELIEF GRIPS | Cord Sealing Grips

Continued from previous page

Nylon Cord Sealing Grips with Mesh, Straight and 90° **

Cat. No. Stainless Steel Mesh		Cat. No. Non-Metallic Mesh		Cable Dia. Range (Inches)	NPT (Form Size)
Straight	90°	Straight	90°		
L7552	L7554	L7553	L7555	.500-.625	3/4" (F3)
L7556	—	—	L7559	.562-.687	3/4" (F3)
L7561	L7563	L7562	—	.625-.750	3/4" (F3)
L7565*	L7566*	—	—	.687-.812	3/4" (F3)
L7567	—	L7568	L7569	.437-.562	1" (F4)
—	L7573	—	L7574	.500-.625	1" (F4)
—	L7582	—	—	.625-.750	1" (F4)
L7584	—	—	L7587	.687-.812	1" (F4)
L7588	—	—	L7592	.750-.875	1" (F4)
L7597	—	—	—	.875-1.000	1" (F4)

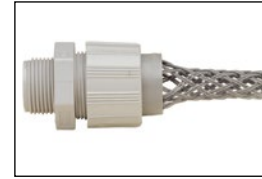

L7553
Straight—nylon mesh

*Cable jacket may have to be stripped for clearance.
 Note: F2, F3 and F4 are fitting form sizes.
 **Cord Sealing Grips with non-metallic mesh are UL Listed and CSA Certified.
 Cord Sealing Grips with stainless steel mesh are CSA Certified only

Nylon Cord-Sealing Fittings, Straight Body

Form 0

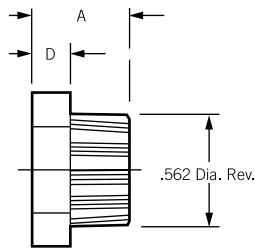

Form 1-5

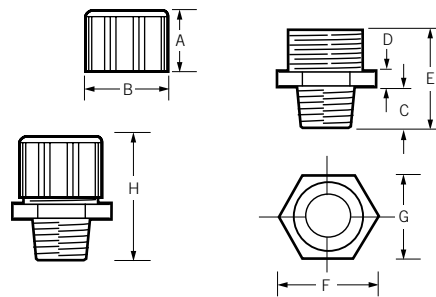

Dimensions for Nylon Cord-Sealing Fittings, Straight Body (units are in inches)

Form	NPT	A	B	C	D	E	F	G	H (Ref.)
0	1/4"	.500	.778	.370	.187	.921	.778	.687	1.25
1	3/8"	1.000	1.150	.500	.250	1.250	1.115	1.000	1.85
2	1/2"	1.000	1.300	.500	.300	1.450	1.250	1.100	2.00
3	3/4"	1.000	1.500	.550	.375	1.700	1.578	1.375	2.00
4	1"	1.000	1.850	.687	.375	1.800	1.900	1.650	2.12

STRAIN-RELIEF GRIPS | Cord Sealing Grips | Deluxe Cord Grips

Cord Sealing Grips

Nylon Cord-Sealing Fittings, 90° Body

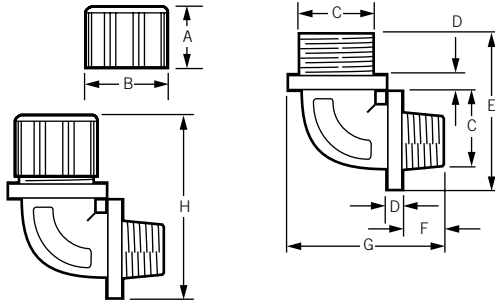

Dimensions for Nylon Cord-Sealing Fittings, 90° Body (units are in inches)

Form	NPT	A	B	C	D	E	F	G	H (Ref.)
1	3/8"	1.000	1.150	1.100	.187	1.812	.450	1.687	2.35
2	1/2"	1.000	1.300	1.165	.187	1.900	.578	1.820	2.40
3	3/4"	1.000	1.500	1.600	.187	2.421	.593	2.218	2.75
4	1"	1.000	1.850	1.850	.187	2.656	.800	2.700	3.00
5	1 1/4"	1.000	2.050	1.965	.187	2.859	.750	2.812	3.25

Deluxe Cord Grips

Deluxe cord grips are woven of stainless steel mesh with an anodized aluminum body for corrosion resistance. They are offered in single/double weave construction to help absorb direct pulling, resist flexing and binding, and eliminate strain. Aluminum fittings are offered in a variety of NPT thread sizes. They are recommended for indoor or outdoor use where moisture may be present in the wiring of pendant stations, processing equipment, hand tools, and extension cord sets. They are UL Listed and CSA Certified. Deluxe cord grips are suitable for use in hazardous locations per Class I, Div. 2; Class II, Div. 1 and 2; and Class III, Div. 1 and 2. They are also suitable for use in wet locations as long as a listed sealing ring is used between the box and the fitting (sealing ring not included).

Single/Double Weave

Cat. No. Straight Male	Cat. No. 90° Male	Cat. No. 45° Male	Cat. No. Straight Female	Cable Dia. Range (Inches)	NPT Size
L7701	—	—	—	.187-.250	3/8"
L7702	—	—	—	.250-.312	3/8"
L7703	—	—	L7822	.312-.375	3/8"
L7704	—	—	—	.375-.437	3/8"
L7705	L7761	—	—	.187-.250	1/2"
L7706	—	L7802	—	.250-.375	1/2"
L7707	L7763	L7803	L7826	.375-.500	1/2"
L7708	L7764	L7804	L7827	.500-.625	1/2"
L7709	—	—	—	.625-.750	1/2"

Continued on next page





L7701
Straight—Male



L7761
90°—Male

STRAIN-RELIEF GRIPS | Deluxe Cord Grips

Continued from previous page

Single/Double Weave  					
Cat. No. Straight Male	Cat. No. 90° Male	Cat. No. 45° Male	Cat. No. Straight Female	Cable. Dia. Range (Inches)	NPT Size
L7711	L7765	L7805	—	.250-.375	3/4"
L7712	—	L7806	—	.375-.500	3/4"
L7700	L7767	L7807	L7831	.500-.625	3/4"
L7713	L7768	L7808	—	.625-.750	1"
L7714	—	—	—	.750-.875	1"
L7715	L7769	—	—	.375-.500	1"
L7716	—	—	L7833	.500-.625	1"
L7717	L7772	—	L7834	.625-.750	1"
L7718	—	—	—	.750-.875	1"
L7719	—	—	L7836	.875-1.000	1"
L7721	—	—	—	1.000-1.125	1"
L7722	—	—	—	1.125-1.250	1"
L7723	—	—	—	.750-.875	1 1/4"
L7724	—	—	—	.875-1.000	1 1/4"
L7725	—	—	—	1.000-1.125	1 1/4"
L7726	L7778	—	—	1.125-1.250	1 1/4"
L7727	—	—	—	1.250-1.375	1 1/4"
L7728	—	—	—	.750-.875	1 1/2"
L7729	L7782	—	—	.875-1.000	1 1/2"
L7731	—	—	—	1.000-1.125	1 1/2"
L7732	L7784	—	—	1.125-1.250	1 1/2"
L7733	L7785	—	—	1.250-1.375	1 1/2"
L8011	—	—	—	1.312-1.437	1 1/2"
L7770	—	—	—	1.437-1.562	1 1/2"
L7750	—	—	—	1.562-1.687	1 1/2"
L7760	—	—	—	1.687-1.812	1 1/2"
L7734	—	—	—	1.250-1.375	2"
L7736	—	—	—	1.562-1.687	2"
L7737	L7789	—	—	1.687-1.812	2"
—	L7791	—	—	1.750-1.875	2"
L7730	—	—	—	2.187-2.312	2"
L7739	—	—	—	1.688-1.812	2 1/2"
L7742	—	—	—	1.937-2.062	2 1/2"
L7743	—	—	—	2.062-2.187	2 1/2"
L7744	—	—	—	2.187-2.312	2 1/2"
L7745	—	—	—	1.688-1.812	3"
L7746	—	—	—	1.812-1.937	3"
L7747	—	—	—	1.937-2.062	3"
L7748	—	—	—	2.062-2.187	3"
L7751	—	—	—	2.312-2.437	3"
L7752	—	—	—	2.437-2.625	3"
L7754	—	—	—	2.812-3.000	3"
L7755	—	—	—	3.000-3.250	3"



L7802
45°—Male

STRAIN-RELIEF GRIPS | Liquid-Tight Grips | Wiring Device I-Grips

Liquid-Tight Grips

Liquid-tight grips are woven stainless steel mesh with zinc-plated steel and malleable iron bodies for corrosion resistance. They are used to connect liquid-tight flexible metal conduit to electrical enclosures to prevent conduit pullout. Each fitting is supplied with an insulated throat to ensure conductor insulation and protect against damage caused by flexing, heat expansion and contraction. Liquid-tight grips are recommended in the wiring of motors and any electrical enclosure where liquid-tight conduit is subject to motion or strain. UL Listed and CSA Certified.

Liquid-Tight Grips for Metallic Conduit

Cat. No. Straight Male	Cat. No. 90° Male	Cat. No. 45° Male	Cat. No. Straight Female	Fitting Size (Inches)	Mesh Length (Inches)
—	—	L7931	L7951	3/8	2 5/8
L7902	L7916	L7932	—	1/2	3 7/8
L7903	L7917	—	L7953	3/4	4 3/8
L7904	L7918	—	L7954	1	5 1/4
L7905	L7919	—	—	1 1/4	5 5/8
L7906	L7921	—	—	1 1/2	5 3/4
L7907	L7922	—	—	2	7 1/2
L7908	—	—	—	2 1/2	9 5/8
L7911	L7924	L7939	—	3	10 5/8
L7912	—	—	—	4	12



L7902
Straight—Male



L7922
90°—Male

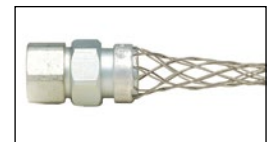

L7951
Straight—Female



L7990
90°—Male

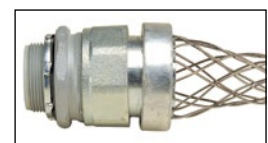

L7965
Straight—Male



L8003

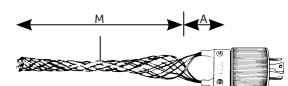

Liquid Tight Grips for Non-Metallic Type “A” Flexible Conduit

Cat. No. Straight Male	Cat. No. 90° Male	Fitting Size (Inches)	Mesh Length (Inches)
L7962	L7990	1/2	10
—	L7967	3/4	10 1/2
—	L7968	1	12
L7965	L7969	1 1/4	17
—	L7971	1 1/2	21 1/2
L7970	L7972	2	24

Wiring Device I-Grips

I-grips provide additional strain-relief for plugs and connectors used on portable equipment in commercial and institutional applications, and industrial plant and construction site areas which incur abnormally high abuse. Grips are made of galvanized steel.

Wiring Device I-Grips

Cat. No.	Cable Dia. Range (Inches)	Eye Dimensions (A) (Inches)	Mesh Length (M) (inches)
L8001	.30-.43	1 11/16	4 3/4
L8002	.40-.56	1 11/16	6
L8003	.52-.73	1 11/16	7
L8004	.70-.85	1 15/16	8 1/2
L8005	.82-1.00	1 15/16	8 1/2
L8006	.94-1.25	1 15/16	10 1/2

SUPPORT GRIPS | Selection Guide

Support Grips

Support grips are designed to hold the weight of cable on vertical or sloping runs. They may be used indoors or outdoors to support electrical and fiber optic cable, metal rods and tubing. Leviton support grips are woven with tinned bronze wire. For applications requiring a greater degree of corrosion resistance, stainless steel wire is available on special order.

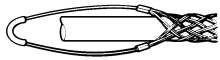

Single "U" Eye

Single "U" Eye

For use when cable is vertical and for applications where cable bends or where a single attachment is more advantageous for positioning.

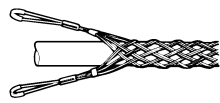

Double "U" Eye

Double "U" Eye

For use when cable is vertical and extends through the grip without bending. Eyes may be fastened to open hooks, but should not be more than 15° from the axis of vertical cable. When eyes are supported equally, this attachment offers a fully balanced load.

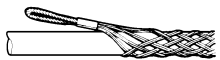

Offset Eye

Offset Eye

Similar to single eye applications, but for use when offset positioning is required.



Locking (Universal) Bale

Locking (Universal) Bale

Adjustable and self-locking, this attachment fits around a beam, pipe or other continuous structural object. The bale wraps around the object and is securely anchored in the bar.

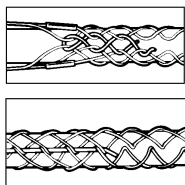

Split Lace

Split Lace

Beginning at the lead end of the grip, thread the lacing through the first two loops of the split, pulling the lace through until the ends are centered evenly. Cross laces and thread through the next two loops, and so on down the grip, being careful not to pull the lacing too tight. The spacing of the lace closure should be approximately the same as that of the mesh weave. When the end of grip is reached, twist the lacing strands tightly together; wrap the ends of the lace around the grip, and twist again to secure. Excess length may be cut off.

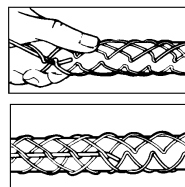

Split Rod

Split Rod

Split grips with rod closing install quickly and they are economical and reusable. Simply wrap the grip around the cable and thread the rod through the loops, using a corkscrew motion. To remove, pull the rod out and the grip is ready for re-use.

SUPPORT GRIPS | Standard Closed Mesh

Support Grips — Standard Closed Mesh

Standard closed mesh support grips are designed for loads up to 500 lbs. and vertical runs of no more than 100 feet. Heavy-duty closed mesh support grips are designed for loads in excess of 500 lbs. They are available in a variety of eye styles and cable ranges for supporting electrical cable, metal rods and tubing. Closed mesh support grips are used when the end of the cable is accessible. Mesh is made of tinned bronze material.

Single Eye, Single Weave

Cat. No.	Cable Dia. Range (Inches)	Approx. (lbs.) Break Strength*	Length (Inches) Bale (Dim. A)	Length (Inches) Mesh (Dim. M)
L9501	0.50-0.61	770	7	11
L9502	0.62-0.74	960	8	11
L9503	0.75-0.99	1,300	8	14
L9504	1.00-1.24	1,680	9	15
L9505	1.25-1.49	1,680	10	16
L9506	1.50-1.74	1,680	12	18
L9507	1.75-1.99	2,640	14	20
L9508	2.00-2.49	3,760	16	22
L9509	2.50-2.99	3,760	18	24
L9511	3.00-3.49	5,040	21	26
L9512	3.50-3.99	5,040	24	28

*To determine workload safety factor, divide approximate break strength by 10

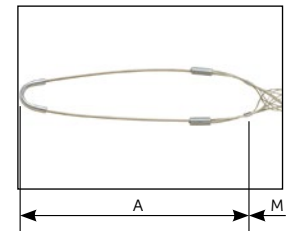

L9502
Single Eye

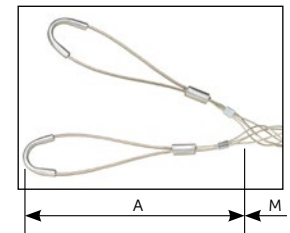

L9515
Double Eye

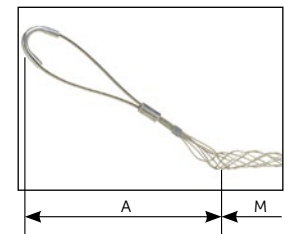

L9531
Offset Eye

Double Eye, Single Weave

Cat. No.	Cable Dia. Range (Inches)	Approx. (lbs.) Break Strength*	Length (Inches) Bale (Dim. A)	Length (Inches) Mesh (Dim. M)
L9515	0.50-0.61	770	4	10
L9516	0.62-0.74	1,150	4	10
L9517	0.75-0.99	1,320	4	12
L9518	1.00-1.24	1,920	5	15
L9519	1.25-1.49	1,920	5	14.25
L9521	1.50-1.74	1,920	6	18
L9523	1.75-1.99	3,360	6	18
L9524	2.00-2.49	3,360	6	19
L9525	2.50-2.99	3,360	6	22
L9526	3.00-3.49	5,280	8	26.75

*To determine workload safety factor, divide approximate break strength by 10

Offset Eye, Single Weave

Cat. No.	Cable Dia. Range (Inches)	Approx. (lbs.) Break Strength*	Length (Inches) Bale (Dim. A)	Length (Inches) Mesh (Dim. M)
L9531	0.50-0.61	770	4	11
L9532	0.62-0.74	960	4	11
L9533	0.75-0.99	960	4	14
L9534	1.00-1.24	1,680	5	15
L9535	1.25-1.49	1,680	5	14.25
L9536	1.50-1.74	1,680	5	18

*To determine workload safety factor, divide approximate break strength by 10

Continued on next page

SUPPORT GRIPS | Standard Closed Mesh | Double Weave, Closed Mesh

Continued from previous page

Offset Eye, Single Weave 				
Cat. No.	Cable Dia. Range (Inches)	Approx. (lbs.) Break Strength*	Length (Inches) Bale (Dim. A)	Length (Inches) Mesh (Dim. M)
L9537	1.75-1.99	2,640	6	20
L9538	2.00-2.49	3,760	6	21
L9539	2.50-2.99	3,760	8	24
L9542	3.50-3.99	5,040	9	28

Note: Support grips are also available in stainless steel—contact your Leviton Representative.
 *To determine workload safety factor, divide approximate break strength by 10

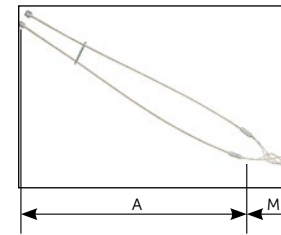

L9551
Locking Bale

Locking Bale, Single Weave 				
Cat. No.	Cable Dia. Range (Inches)	Approx. (lbs.) Break Strength*	Length (Inches) Bale (Dim. A)	Length (Inches) Mesh (Dim. M)
L9551	0.50-0.61	770	11	10
L9552	0.62-0.74	1,150	11	10
L9553	0.75-0.99	1,320	14	12
L9554	1.00-1.24	1,920	15	15
L9555	1.25-1.49	1,920	16	14.25
L9556	1.50-1.74	1,920	18	18
L9558	2.00-2.49	3,360	21	19
L9559	2.50-2.99	3,360	24	22

*To determine workload safety factor, divide approximate break strength by 10

Support Grips — Heavy Duty, Double Weave, Closed Mesh

Heavy duty support grips handle continuous loads of over 500 lbs. in vertical runs greater than 100 ft. for cable diameters from 3/4" to 4 1/2".

Single Eye, Heavy Long 				
Cat. No.	Cable Dia. Range (Inches)	Approx. (lbs.) Break Strength*	Length (Inches) Bale (Dim. A)	Length (Inches) Mesh (Dim. M)
L9701	0.75-0.99	2,700	10	26
L9702	1.00-1.24	4,720	10	31.50
L9703	1.25-1.49	4,720	10	31
L9704	1.50-1.99	4,720	10	35

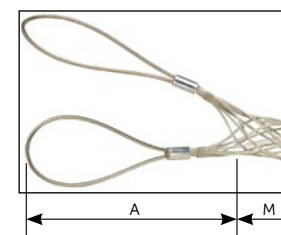

L9715
Double Eye

Double Eye, Heavy Long 				
Cat. No.	Cable Dia. Range (Inches)	Approx. (lbs.) Break Strength*	Length (Inches) Bale (Dim. A)	Length (Inches) Mesh (Dim. M)
L9711	0.75-0.99	2,700	10	26
L9712	1.00-1.24	4,720	10	29
L9713	1.25-1.49	4,720	10	31
L9714	1.50-1.99	4,720	10	35
L9715	2.00-2.49	10,080	10	37
L9716	2.50-2.99	10,080	10	39
L9717	3.00-3.49	10,080	10	41
L9718	3.50-3.99	13,120	10	45
L9719	4.00-4.49	13,120	10	47

*To determine workload safety factor, divide approximate break strength by 10

SUPPORT GRIPS | Split Lace, Single Weave

Support Grips — Standard Split Lace, Single Weave

Split lace support grips are designed for loads up to 500 lbs. and vertical runs of no more than 100 feet. They are available in a variety of eye styles and cable ranges for supporting electrical cable, metal rods and tubing. Split lace grips are utilized when the end of the cable cannot be feasibly accessed and the support grip is intended for permanent installation. Mesh is made of tinned bronze material.

Single Eye				
Cat. No.	Cable Dia. Range (Inches)	Approx. (lbs.) Break Strength*	Length (Inches) Bale (Dim. A)	Length (Inches) Mesh (Dim. M)
L9571	0.50-0.61	770	8	11
L9572	0.62-0.74	960	8	11
L9573	0.75-0.99	1,320	8	14
L9574	1.00-1.24	1,680	9	15
L9575	1.25-1.49	1,680	10	16
L9576	1.50-1.74	1,680	12	18
L9577	1.75-1.99	2,640	14	20
L9578	2.00-2.49	3,760	16	22
L9579	2.50-2.99	3,760	18	24
L9581	3.00-3.49	5,040	20	26
L9582	3.50-3.99	5,040	22	28

*To determine workload safety factor, divide approximate break strength by 10

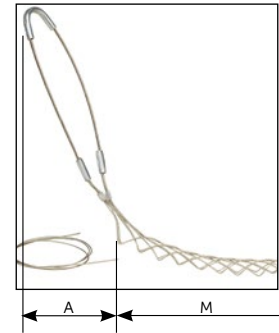

L9571
Single Eye

Double Eye				
Cat. No.	Cable Dia. Range (Inches)	Approx. (lbs.) Break Strength*	Length (Inches) Bale (Dim. A)	Length (Inches) Mesh (Dim. M)
L9585	0.50-0.61	770	4	11
L9586	0.62-0.74	1,150	4	11
L9587	0.75-0.99	1,320	4	14
L9588	1.00-1.24	1,920	5	15
L9589	1.25-1.49	1,920	5	16
L9591	1.50-1.74	1,920	5	18
L9592	1.75-1.99	3,150	6	20
L9593	2.00-2.49	3,360	6	22
L9595	3.00-3.49	5,280	8	26
L9596	3.50-3.99	5,280	8	28

*To determine workload safety factor, divide approximate break strength by 10

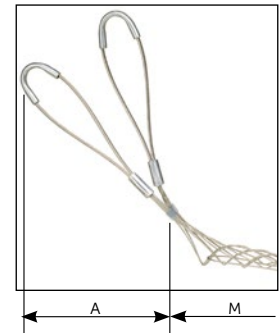

L9585
Double Eye

Offset Eye				
Cat. No.	Cable Dia. Range (Inches)	Approx. (lbs.) Break Strength*	Length (Inches) Bale (Dim. A)	Length (Inches) Mesh (Dim. M)
L9601	0.50-0.61	770	4	11
L9602	0.62-0.74	960	4	10.50
L9603	0.75-0.99	960	4	14
L9604	1.00-1.24	1,680	5	15
L9605	1.25-1.49	1,680	5	14.25
L9606	1.50-1.74	1,680	5	18
L9608	2.00-2.49	3,760	8	22
L9609	2.50-2.99	3,760	8	24
L9612	3.50-3.99	5,040	9	28

Note: Support grips are also available in stainless steel — contact your Leviton Representative.

*To determine workload safety factor, divide approximate break strength by 10

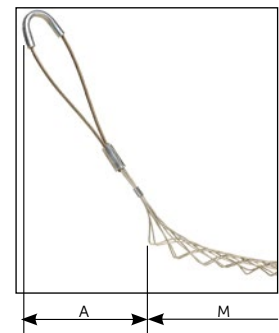

L9601
Offset Eye

SUPPORT GRIPS | Split Lace, Single Weave | Double Weave

Locking Bale 				
Cat. No.	Cable Dia. Range (Inches)	Approx. (lbs.) Break Strength*	Length (Inches) Bale (Dim. A)	Length (Inches) Mesh (Dim. M)
L9621	0.50-0.61	770	18	11
L9622	0.62-0.74	1,150	18	11
L9623	0.75-0.99	1,320	18	14
L9624	1.00-1.24	1,920	18	15
L9625	1.25-1.49	1,920	18	16

*To determine workload safety factor, divide approximate break strength by 10

Support Grips — Heavy Duty Split Lace, Double Weave

Split lace support grips are designed for loads up to 500 lbs. and vertical runs of no more than 100 feet. They are available in a variety of eye styles and cable ranges for supporting electrical cable, metal rods and tubing. Split lace grips are utilized when the end of the cable cannot be feasibly accessed and the support grip is intended for permanent installation. Mesh is made of tinned bronze material.

Single Eye, Heavy, Long 				
Cat. No.	Cable Dia. Range (Inches)	Approx. (lbs.) Break Strength*	Length (Inches) Bale (Dim. A)	Length (Inches) Mesh (Dim. M)
L9722	0.75-0.99	2,700	10	26
L9723	1.00-1.24	4,720	10	29
L9724	1.25-1.49	4,720	10	31
L9725	1.50-1.99	4,720	10	35

*To determine workload safety factor, divide approximate break strength by 10

Double Eye, Heavy, Long 				
Cat. No.	Cable Dia. Range (Inches)	Approx. (lbs.) Break Strength*	Length (Inches) Bale (Dim. A)	Length (Inches) Mesh (Dim. M)
L9731	0.75-0.99	2,700	10	26
L9732	1.00-1.24	4,720	10	29
L9733	1.25-1.49	4,720	10	31
L9734	1.50-1.99	4,720	10	35
L9735	2.00-2.49	10,080	10	37
L9736	2.50-2.99	10,080	10	39
L9737	3.00-3.49	10,080	10	41
L9738	3.50-3.99	13,120	10	45
L9739	4.00-4.49	13,120	10	47

*To determine workload safety factor, divide approximate break strength by 10

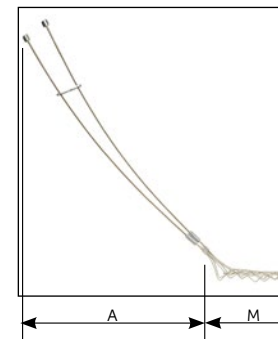

L9621 Locking Bale

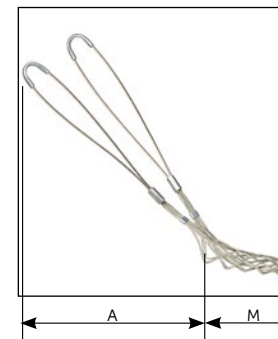

L9731 Double Eye

SUPPORT GRIPS | Standard Split Rod, Single Weave

Support Grips — Standard Split Rod, Single Weave

Split rod support grips are designed for loads up to 500 lbs. and vertical runs of no more than 100 feet. They are available in a variety of eye styles and cable ranges for supporting electrical cable, metal rods and tubing. Split rod support grips are utilized when the end of the cable cannot be feasibly accessed and the installation is temporary.

Single Eye

Cat. No.	Cable Dia. Range (Inches)	Approx. (lbs.) Break Strength*	Length (Inches) Bale (Dim. A)	Length (Inches) Mesh (Dim. M)
L9631	0.50-0.61	770	7	9
L9632	0.62-0.74	960	8	10
L9633	0.75-0.99	1,320	8	11
L9634	1.00-1.24	1,680	9	15
L9635	1.25-1.49	1,680	10	13.5
L9636	1.50-1.74	1,680	12	16
L9637	1.75-1.99	2,640	14	20
L9638	2.00-2.49	3,760	16	20
L9639	2.50-2.99	3,760	18	25
L9641	3.00-3.49	6,560	21	24
L9642	3.50-3.99	6,560	24	26

*To determine workload safety factor, divide approximate break strength by 10

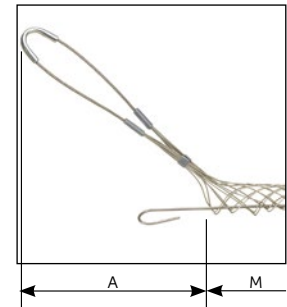

L9632
Single Eye

Double Eye

Cat. No.	Cable Dia. Range (Inches)	Approx. (lbs.) Break Strength*	Length (Inches) Bale (Dim. A)	Length (Inches) Mesh (Dim. M)
L9651	0.50-0.61	770	4	9
L9652	0.62-0.74	1,150	4	9
L9653	0.75-0.99	1,320	4	11
L9654	1.00-1.24	1,920	5	13
L9655	1.25-1.49	1,920	5	15
L9656	1.50-1.74	1,920	5	16
L9657	1.75-1.99	3,150	6	17
L9658	2.00-2.49	3,360	6	20
L9659	2.50-2.99	3,360	6	22
L9661	3.00-3.49	7,520	8	24
L9662	3.50-3.99	7,520	8	26

*To determine workload safety factor, divide approximate break strength by 10

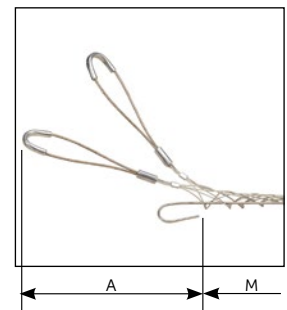

L9651
Double Eye

Offset Eye

Cat. No.	Cable Dia. Range (Inches)	Approx. (lbs.) Break Strength*	Length (Inches) Bale (Dim. A)	Length (Inches) Mesh (Dim. M)
L9671	0.50-0.61	770	4	9
L9672	0.62-0.74	960	4	9
L9673	0.75-0.99	960	4	11
L9674	1.00-1.24	1,680	5	13
L9675	1.25-1.49	1,680	5	15
L9676	1.50-1.74	1,680	5	16
L9677	1.75-1.99	2,640	6	17
L9678	2.00-2.49	3,760	6	20
L9679	2.50-2.99	3,760	6	22
L9681	3.00-3.49	5,040	8	24
L9682	3.50-3.99	5,040	8	26

*To determine workload safety factor, divide approximate break strength by 10

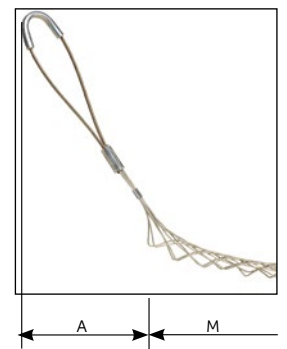

L9671
Offset Eye

SUPPORT GRIPS | Standard Split Rod, Single Weave | Bus Drop

Locking Bale 				
Cat. No.	Cable Dia. Range (Inches)	Approx. (lbs.) Break Strength*	Length (Inches) Bale (Dim. A)	Length (Inches) Mesh (Dim. M)
L9688	0.50-0.61	770	10	9
L9689	0.62-0.74	1,150	10	9
L9691	0.75-0.99	1,320	10	11
L9692	1.00-1.24	1,920	14	13
L9693	1.25-1.49	1,920	14	15
L9694	1.50-1.74	1,920	14	16
L9695	1.75-1.99	3,150	14	17
L9696	2.00-2.49	3,360	18	20
L9698	3.00-3.49	7,520	18	24

*To determine workload safety factor, divide approximate break strength by 10

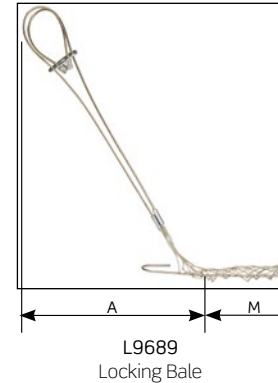

Support Grips — Bus-Drop

Bus-drop grips are used as cable support. They relieve any direct tension from the critical connection and absorb vibration and flexing. Bus-drop grips are woven of galvanized steel wire. They are offered with either locking bale or single eye attachments.

Locking Bale and Single Eye 			
Cat. No. Single "U" Eye	Cat. No. Locking Bale	Cable Dia. Range (Inches)	Approx. (lbs.) Break Strength*
L7981	—	.220-.320	1,100
L7982	—	.300-.430	1,100
L7983	L7992	.400-.560	1,100
L7984	L7993	.530-.730	1,100
L7985	L7994	.700-.850	1,900
L7986	L7995	.820-1.00	1,900
L7987	—	.960-1.25	1,900

*To determine workload safety factor, divide approximate break strength by 10



Support Grips — Bus-Drop Accessories

Safety springs are used with bus-drop grips to relieve sudden strains on the cable system. To use with single eye-type grips, disassemble drawbar from coil, place through the eye, and replace the drawbar.

Safety Springs		
Description	Cat. No.	Length (Inches)
Zinc Plated, Max. Load 40 Lbs.	L7997	7.50
Zinc Plated, Max. Load 80 Lbs.	L7998	8.50

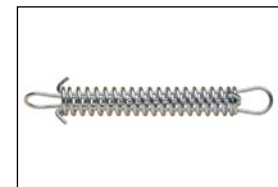

SUPPORT GRIPS | Fiber Optic, Single Weave

Support Grips — Fiber Optic Grips, Single Weave

All Leviton fiber optic support grips are designed to wrap securely around fiber optic cable without damaging it. They are designed to reduce stress on cable in vertical, sloping, or horizontal positions. Single-eye or locking-bale style grips afford lasting support for a wide variety of applications where fiber optic cable is used.

Single Eye, Closed Mesh

Cat. No.	Cable Dia. Range (Inches)	Approx. (lbs.) Break Strength*	Length (Inches) Bale (Dim. A)	Length (Inches) Mesh (Dim. M)
L8807	.18-.25	300	3	1.7
L8808	.23-.32	300	3	2.5
L8809	.30-.39	300	4	2.5
L8811	.37-.48	300	5	4.0
L8812	.46-.58	400	6	4.0
L8813	.56-.71	600	7	5.5
L8814	.69-.88	800	8	6.0

*To determine workload safety factor, divide approximate break strength by 10

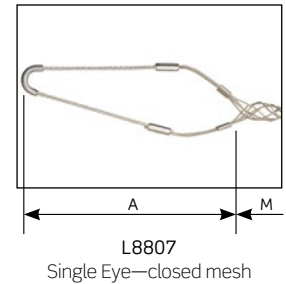

Single Eye, Split Rod

Cat. No.	Cable Dia. Range (Inches)	Approx. (lbs.) Break Strength*	Length (Inches) Bale (Dim. A)	Length (Inches) Mesh (Dim. M)
L8815	.18-.25	300	3	2.5
L8816	.23-.32	300	3	2.5
L8817	.30-.39	300	4	2.5
L8818	.37-.48	300	5	4.0
L8819	.46-.58	400	6	5.0
L8821	.56-.71	600	7	5.0
L8822	.69-.88	800	8	6.0

*To determine workload safety factor, divide approximate break strength by 10

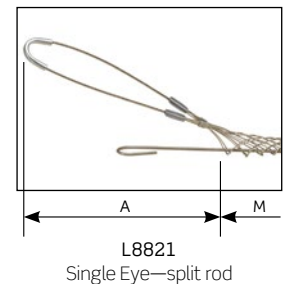

Locking Bale, Closed Mesh

Cat. No.	Cable Dia. Range (Inches)	Approx. (lbs.) Break Strength*	Length (Inches) Bale (Dim. A)	Length (Inches) Mesh (Dim. M)
L8823	.18-.25	300	9	1.7
L8824	.23-.32	300	9	2.5
L8825	.30-.39	300	9	2.5
L8826	.37-.48	300	10	4.0
L8827	.46-.58	400	10	4.0
L8828	.56-.71	600	10	5.5
L8829	.69-.88	800	10	6.0

*To determine workload safety factor, divide approximate break strength by 10

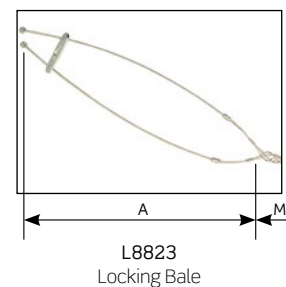

Leviton Manufacturing Co., Inc.

201 N Service Rd, Melville, NY 11747

Telephone: 1-800-323-8920 • FAX: 1-800-832-9538

Tech Line (8:30AM-7:00PM E.S.T. Monday-Friday): 1-800-824-3005

Visit our Website at: www.leviton.com email: industrial@leviton.com

© 2015 Leviton Manufacturing Co., Inc. All rights reserved. Specifications subject to change without notice.

Q-1018